

S8 TIGER Series 2

● Spectrometry Solutions





HighSense



XRF²



EZ Ergo



Sample Handling



S8 TIGER Series 2 – Take the Next Step in Analytical Performance and Flexibility!



HighSense: Accuracy and precision are vital for industrial quality and process control analytics. Close control levels and tight sample grids in elemental analysis are the success factors for better quality and cost efficiency. The S8 TIGER WDXRF spectrometer is the ideal analytical tool for these tasks: Thanks to HighSense technology it delivers the optimal sensitivity for all elements from Beryllium (Be) to Americium (Am). HighSense technology includes new XS-Series analyzer crystals, the HighSense counting electronics, and the HighSense X-ray tubes. This enables the S8 TIGER Series 2 to deliver a maximum performance for fastest time-to-result, lowest detection limits, and best analytical precision.

XRF²: Analytical flexibility is of foremost importance in research and academia. The analysis of all materials, including bulk samples, small particles or the analysis of elemental distributions, are perfectly mastered with the all-new S8 TIGER Series 2. With the HighSense beam path, high-resolution WDXRF technology, and optimal detection of light, medium, and heavy elements, the XRF² mapping tool of the S8 TIGER Series 2 delivers best sensitivity, smallest spot size down to 300 μm , and highest resolution for small-spot applications.

EZ Ergo: Ergonomic and failsafe usability is vital for operations efficiency and best analytical data. Ease-of-use operation is guaranteed with the multilingual TouchControl interface on the S8 TIGER Series 2. The EasyLoad magazines allow easy handling of all sample types. Optimal instrument uptime and low running cost are guaranteed by SampleCare technology which protects the S8 TIGER Series 2 components.

Simply get the best with the S8 TIGER Series 2:

- Best accuracy and precision for quality and process control: HighSense technology for ultimate sensitivity and detection limits
- Ultimate analytical flexibility for research and academia: XRF² mapping with smallest spot size (300 μm FWHM) and 100 μm step size
- EZ Ergo for ergonomic, failsafe operation with TouchControl for unique ease-of-use
- Optimal system uptime and lowest cost of operation with SampleCare technology

S8 TIGER Series 2 with HighSense Technology: Impressive Performance

The goal of any analysis is to produce the most accurate results with highest precision in the shortest possible time. In elemental analysis, speed leads to the shortest time-to-result and the highest sample throughput. Speed, accuracy and reliability demand outstanding technology.

This is where the S8 TIGER Series shines: Every single component in the beam path was designed for performance and robustness. It starts with the unrivalled flexible Bruker HV generator and the HighSense X-ray tubes with up to 170 mA for optimal excitation. A series of our XS analyzer crystals from the XS-Series are enabling the S8 TIGER Series 2 for highest intensity, best precision

and optimal resolution in various applications: The XS-400 crystals delivers 35% higher intensity over the entire element range from K – Am. The XS-CEM brings ultimate precision for Al and Si in cement and mineral applications.

As a highlight the new HighSense counting electronics delivers ultimate high linear count rates for both, the scintillation and proportional counter. With the DynaMatch technology this range even goes up to 13 Mcps – This makes the S8 TIGER Series 2 the perfect choice for process control applications achieving, highest precision and maximum sample throughput.



S8 TIGER Series 2 for industrial quality and process control – Higher accuracy and precision with HighSense technology

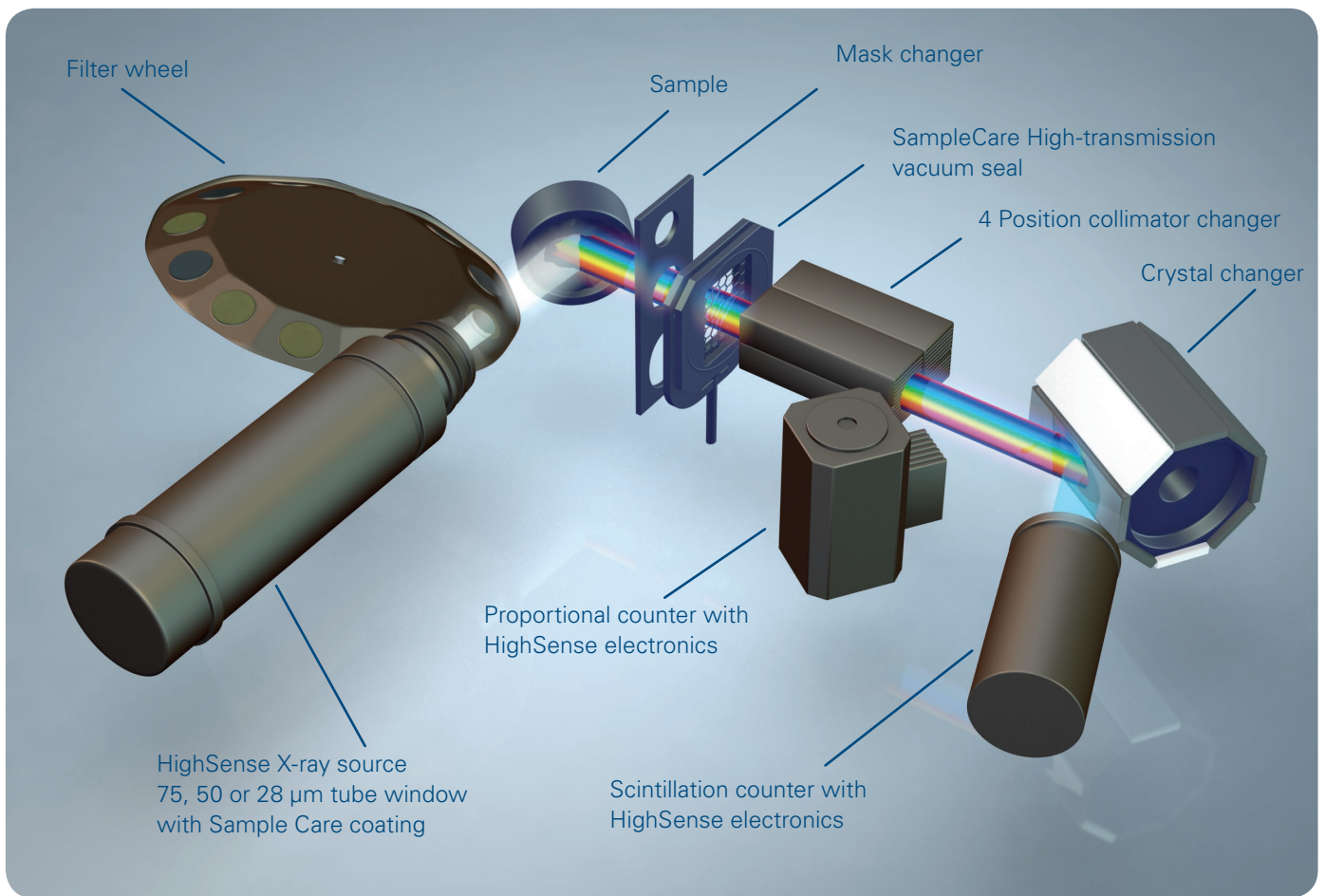

HighSense X-ray beam path of the S8 TIGER Series 2

S8 TIGER Series 2 HighSense Technology

- The **HighSense X-ray tube** and primary radiation filter guarantee that each element in the sample is optimally excited. Gain more than 35% more intensity for light elements with the 28 μm window.
- The **automatic mask changer** adjust to the sample size and carries the **HighSense XRF²** beam guide snorkel mask. The intensity in mapping is up to 10 times higher than with conventional WDXRF systems.
- The **High-transmission vacuum seal** separates as part of SampleCare the sample and goniometer chamber – it dramatically reduces cost of operation and enhances system uptime.
- **Four position collimator changer** enables users to make the optimal choice between intensity and resolution. This is makes the S8 TIGER Series 2 the most flexible WDXRF system.
- **The analyzer crystals** play a crucial role: They break down the fluorescence spectrum into the specific wavelengths for the elements: The advanced Bruker XS crystals are enhancing the S8 TIGER Series 2 in sensitivity, detection limits, resolution, analysis speed and precision.
- For the detection of light elements a **proportional counter** and for the heavier elements a **scintillation counter** is used. Both detectors are perfectly suited for WDXRF applications with ultimate linear range applying DynaMatch with up to 13 Mcps counts.

Excitation



High Voltage Generator

- 1 kW up to 50 mA
- 3 kW up to 150 mA
- 4 kW up to 170 mA

**Current
170 mA**

Precision and flexibility

- DynaMatch: Unrivalled flexibility, instant switch from 20 to 60 kV and 5 to 170 mA
- Best HV precision: $< \pm 0.00005$
- 170 mA for best light element excitation



High Intensity X-ray tube

- 75 μm Be Window
- Closest coupling anode to sample
- Long life: 2 years warranty

Sample

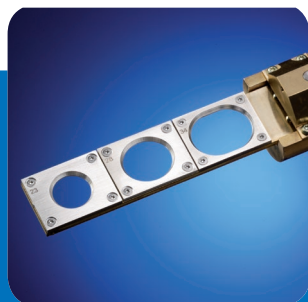

Automatic mask changer

- Options for 34, 28, 23, 18, 8, 5, 1,25 and 0,3 mm masks
- SampleCare shield to protect the goniometer



Small spot analysis

- Snorkel masks: 8, 5, 1,25 and 0,3 mm
- Beamguide technology for lowest background and higher intensity



High-transmission vacuum

- Separates sample and goniometer chamber
- No loss on intensity
- Instant switch solid – liquid

Intensity/ Resolution



Automatic 4 position collimator

- Best analytical flexibility
- Optimized sensitivity and resolution
- different openings from 0.12 – 2°

XS-GE-C

XS-Series Crystals

- Selection of more than 16 crystals available
- Application optimized analyzer crystals

**S
+ 20%**

XS-GE-C analyzer Crystal

- 40% more intensity for P
- 20% higher count rates for
- 0.2 ppm detection limit for

Detection



Detectors

- High efficiency flowcounter for light element detection
- High sensitivity flowcounter for optimal heavy element detection

**Ultimate
Linear
Range**

HighSense MCA

- Countrates up to 3.5 Mcps
- Wide calibration ranges
- On the fly dead time correction

**DynaMatch
13 Mcps**

DynaMatch

- 13 Mcps max countrate
- Enhanced standardless analysis
- No method setup for major unknown samples

HighSense 50 µm

HighSense X-ray tube 50 µm

- 15% higher intensity (light elements)
- 50 µm Be Window
- SampleCare coating

HighSense 28 µm

HighSense X-ray tube 28 µm

- 35% higher intensity (light elements)
- 28 µm Be Window
- SampleCare coating



Primary Beam Filters

- 10 positions beam filter
- Optimal peak to background ratios
- SampleCare tube shield

Sample Care

SampleCare

- Shields goniometer
- Best instrument uptime
- SampleCare coating

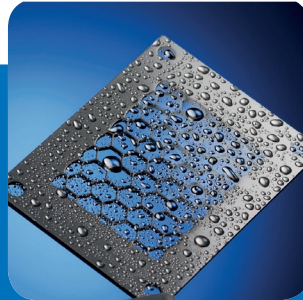

SampleCare

- Locks out drops and particles
- Protects components
- Enhances instrument uptime

He purge – 60%

Economic Helium mode

- Reduced Helium mode for oils
- Saves 60% of He
- Atmospheric He mode for volatile samples

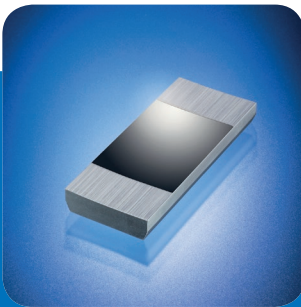

High intensity crystal XS-400

- Covers K – Am
- Proprietary crystal structure
- For precision in mining and metals

XS-400 + 35%

High intensity crystal XS-400

- Saves > 35% counting time per element
- Replaces expensive 3rd detectors
- More efficient than sealed gas counters

N + 100%

Nitrogen with XS-N HighSense

- 2 times higher intensity for N
- Time saving
- 30 % better detection limits for N

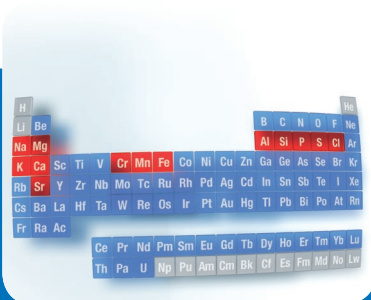

ElectronicGearing

- Less than 2 minutes scan
- Simultaneous alignment of all drives
- Up to 1200° scan speed

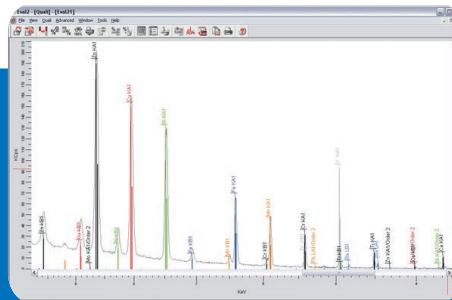

Fast monitoring

- High precision goniometer
- Reproducibility better than $\pm 0,0001^\circ$
- Digital optical encoders

XRF² in the S8 TIGER Series 2 – Explore the Microcosmos !



Element mapping and particle analysis is crucial for troubleshooting in production and material research. Mapping is a straightforward task with XRF in contrast to electron microscopes due to the simple sample preparation and it is even easier with the S8 TIGER Series 2: Intuitive quick setup of measurements and powerful graphical reporting are easily achieved with the Mapping Client of SPECTRAplus.

The XRF² mapping tool of the S8 TIGER Series 2 offers unrivalled analytical performance: With a spot size as low as 300 µm (FWHM) and 100 µm step size, the S8 TIGER sets the benchmark in its class! With up to 10 times higher sensitivity due to HighSense mapping optics, the S8 TIGER Series 2 is ideal for elemental mapping of major, minor, and trace elements. Using its WDXRF goniometer, the S8 TIGER delivers better resolution and more efficient light and heavy element detection than EDXRF based mapping systems.

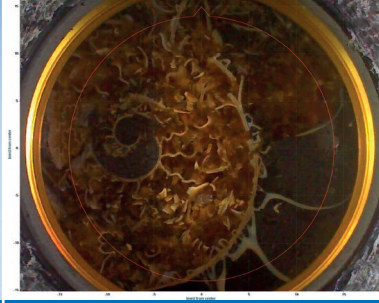

S8 TIGER Series 2 with XRF² mapping: An indispensable analytical tool for trouble shooting in production and laboratories for material research and academia.

XRF² Mapping

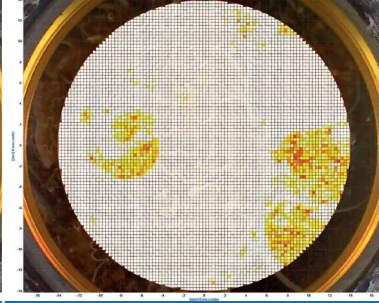
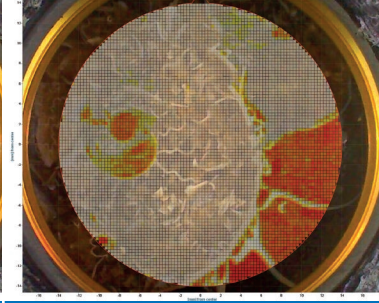
				
<p>Geochemical mapping in Palaeontology: Fossilized ammonite shell with different chamber fillings</p>	<p>Sample view with HD camera of the Mapping Client in the S8 TIGER Series 2: High-resolution image for definition of freely selectable scan area</p>	<p>Strontium concentration traces white shell remnants and is highest in outer shell and lowest in crosspieces of compartments</p>		
				
<p>Chamber filling (I): Ca concentration correlating with beige brown filling</p>	<p>Chamber filling (II): Si concentration correlates well with dark grey filling at center and entrance of ammonite shell</p>	<p>Chamber filling (III): Fe concentration shows positive correlation with Si concentration and is highest at shell entrance</p>		

Highlights of XRF² Mapping

Smallest Spot Size !

- 300 µm
- 1,25 mm alternatively

100 µm step size

- High resolution spatial mapping

WDXRF performance

- Best light element analysis with dedicated proportional counter
- Optimal heavy element detection with scintillation counter
- High WDXRF resolution

Best intensity

- More than ten times higher sensitivity
- HighSense beam path
- Trace element detection in mapping



Load any kind of sample – being productive with EZ Ergo!



75 Pos EasyLoad Magazine (71 Pos, when automated with liquid sample detection)



60 Pos Sample Cup Loader for heavy samples and XRF2 mapping with HD camera



108 Pos. bare samples with vacuum grabber for flat samples (pressed pellets and fused beads)

EasyLoad makes work incredibly simple and gives you a sure hand: Either insert samples into one of the fixed positions or fill a prepared sample tray as required, start the measurement or a whole mixed series of measurements and ... that's it!

Thanks to EasyLoad that is all you have to do and you need not worry that anything will go wrong. Owing to the automatic identification of the sample type – solid or liquid – EasyLoad reliably prevents incorrect operation, such as measurement of liquids or loose powders under vacuum.

In combination with the intuitive interface TouchControl the S8 TIGER Series 2 becomes an incredible ergonomic lab instrument – we call this EZ Ergo!

Sample magazine for every need:

- 75 Pos EasyLoad with two sample trays for convenient loading
- Automatic liquid sample detection
- 60 Pos. sample cup magazine for flexibility in sample handling, from light to heavy, from large to small
- 108 Pos bare flat samples for maximum productivity with vacuum grabber
- Combination of magazines for cups and bare samples

Automation:

- Automation interface to belt and conveyors
- AXSCOM SW interface to automation

1

The measurement of any ample is as simple as it could be: Just place the sample in the magazine and select the application! Perfect for industrial use: All routine applications are quick start buttons!

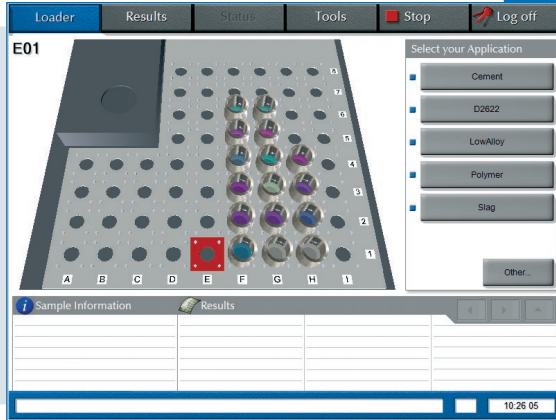

2

Quick: Now you type in the sample ID. Direct on the touchscreen, no hassle with a PC, mouse or keyboard: Simply press "MEASURE" to analyze! There is nothing to remember, it's simply step-by-step.

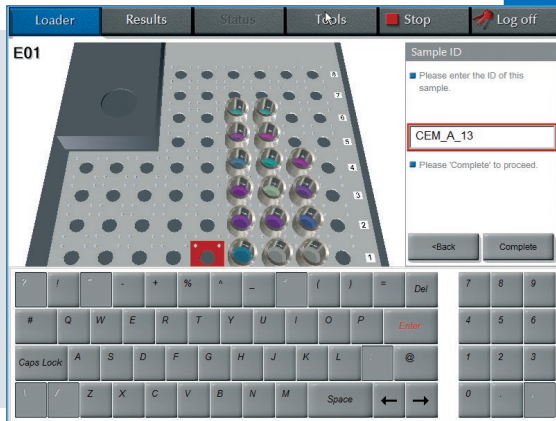

3

Instant results: Each result is displayed on the touchscreen, sent to the printer and stored in the results database. Limit values are checked automatically and reported color coded. Different user access levels protect relevant data!

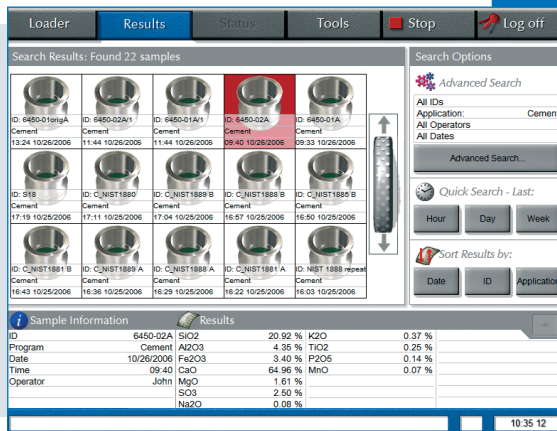

TouchControl: Analyze'n Go – intuitive quick sample start, adjustable

SPECTRA^{plus} and QUANT-EXPRESS – That is so easy !

- User-specific calibration (e.g.)
- Added elements with QUANT-EXPRESS calibration
- Elements with QUANT-EXPRESS calibration
- Not available

Unlimited flexibility with QUANT-EXPRESS: full standardless analysis or any combination with standard-based calibrations and QUANT-EXPRESS calibrated lines

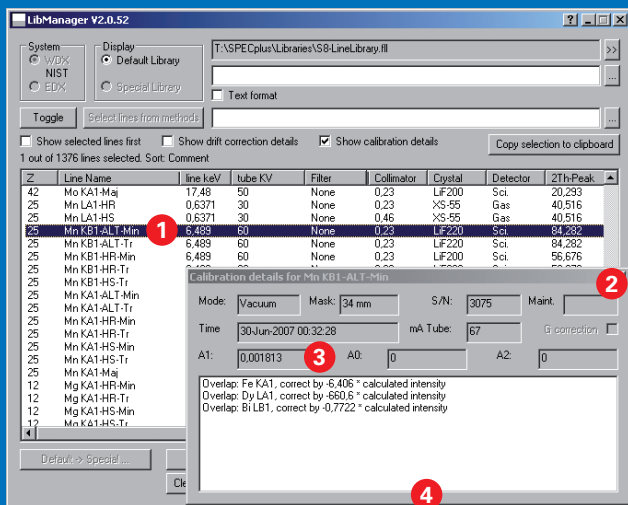

QUANT-EXPRESS™: Unique Line Library with Integrated Analytical Intelligence

- 1 Element line for a specific concentration range
- 2 Measurement conditions (peak position, excitation parameters, crystal, collimator, detector)
- 3 Calibration coefficients
- 4 Overlapping lines with correction factors

QUANT-EXPRESS is the unique standardless software: You benefit both from the advantages of customized calibrations with your own standards (maximum accuracy and maximum precision), as well as from the flexibility and versatility of QUANT-EXPRESS.

QUANT-EXPRESS comprises a unique multi-purpose calibration prepared by Bruker using innumerable certified standards. All our experience of decades in XRF are made available with these calibrations and measurement methods. We call it: integrated Analytical Intelligence.

QUANT-EXPRESS not only enhances the potential of your routine system, it also assists you with other tasks. When setting up your own calibrations, QUANT-EXPRESS automatically creates the optimal measurement method to match each element and every concentration range – quickly simply, and reliably.

The real class of QUANT-EXPRESS comes fully into account, when performing the fast, reliable, and complete analysis of unknown solid and liquid samples. Less than two minutes for a qualitative and quantitative screening of unknown samples – only QUANT-EXPRESS™ can do that for you.

The S8 TIGER Series 2 comes with SPECTRA^{plus} – the comprehensive analytical XRF software package making setup, operation and data maintenance easy, yet powerful.

Application

It is quite simple to create applications: SPECTRA^{plus} directly follows your workflow - from the definition of standard samples, through sample preparation, the calculation of the calibration and on to the final release of the application. SPECTRA^{plus} supports you in all these steps. When creating your own measurement method, the integrated Analytical Intelligence assists you to utilize the performance of the S8 TIGER.

Measurement

To start your measurements, you only enter the preparation parameters and assign the measurement method. That's all! With a simple click you can even launch a whole series of samples.

Evaluation

Whether it is qualitative or quantitative evaluation – SPECTRA^{plus} leaves all options open: Scan measurements are always evaluated fully automatically, the elements are identified and the concentrations are calculated. If you like, you can check and refine the results interactively.

Reporting

You define your own printout format, summarize the results in tables, and export the data to other programs just as you wish and need. For GLP compliant documentation the results are also archived in SPECTRA^{plus}.

- Seamless integrated standardless evaluation for all kind of samples
- Complete easy-to-use analytical software package for calibration, evaluation and reporting
- Integrated Analytical Intelligence to achieve maximum analytical performance
- Powerful state-of-the art fundamental parameter matrix correction with unique variable alphas

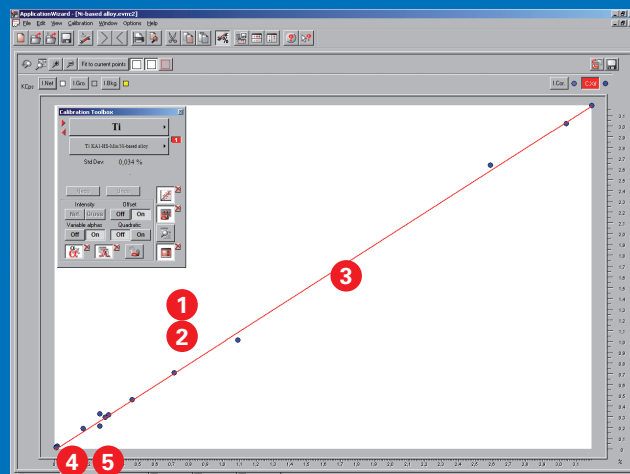

CALIBRATION

- Element with selected analytical line
- Calculated deviation of the calibration
- Calibration curve
- Matrix correction model: FP, variable alpha model, empirical, theoretical,...
- Overlay correction

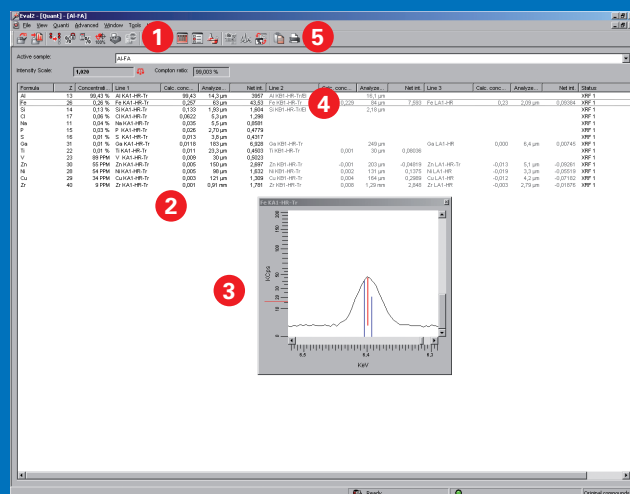

INTERACTIVE QUANTITATIVE EVALUATION

- Sample ID, database search
- Element with calculated result, analytical line
- Display of selected element peak
- Alternative analytical line
- Data export to result database, export and print

S8 TIGER Series 2 – The perfect fit for every need

Customize for your application

Minerals, Mining, Geology



HighSense technology

- Ultimate linear detector ranges
- Enhanced element sensitivities
- XS-100 analyzer crystal for short measurement times
- XS-400 analyzer crystal for 35% higher intensity

Metals



HighSense technology

- Ultimate linear detector ranges
- Enhanced element sensitivities
- XS-400 analyzer crystal for 35% higher intensity
- 30% less background for carbon with XS-C

Cement



HighSense technology

- Ultimate linear detector ranges
- Enhanced analytical precision and longterm stability with XS-CEM analyzer crystal
- High sulfur precision and speciation with XS-Ge-C
- AXSCOM interface for straight forward integration to automations

	<ol style="list-style-type: none"> 1) GEO-QUANT Basic for majors and minors in geological materials 2) GEO-QUANT Advanced for majors and minors in oxides for minerals, ores, ceramics, glass, raw materials 3) GEO-QUANT T for trace element determination in all geological samples 4) GEO-QUANT Iron Ore for grade control acc. to ISO 9516 	<ul style="list-style-type: none"> ▪ Optimal precision and detection limits ▪ High sample throughput ▪ High productivity with EasyLoad ▪ Failsafe operation with TouchControl ▪ Best results and data quality based on Bruker solutions ▪ High instrument uptime with DirectLoading and S8 Tools 	
	<ol style="list-style-type: none"> 1) METAL-QUANT for iron and copper based alloys 2) SLAG-QUANT for accurate analysis of slag composition from blast furnace and EAF operations, as well as in DRI and for ladle slags 3) ML plus for coating thickness analysis (single and multiple layers) 	<ul style="list-style-type: none"> ▪ Cost savings with fastest time to result ▪ High sample throughput ▪ Optimal precision and detection limits ▪ Failsafe operation with TouchControl ▪ Best results and data quality based on Bruker solutions ▪ Analytical flexibility for metals, raw materials and final products in one instrument ▪ High instrument uptime with DirectLoading and S8 Tools 	
	<ol style="list-style-type: none"> 1) CEMENT-QUANT for norm compliant analysis of cements according to ASTM C 114, ISO 29581, EN 196-1 2) GEO-QUANT Basic for majors and minors in raw materials 3) GEO-QUANT T for trace element determination for green eco cements 	<ul style="list-style-type: none"> ▪ Optimal precision and detection limits ▪ High sample throughput ▪ High productivity with EasyLoad ▪ Failsafe operation with TouchControl ▪ Best results and data quality based on Bruker solutions ▪ Flawless integration to automation and data transfer ▪ High instrument uptime with DirectLoading and S8 Tools 	

Petro



- Ultra-low detection limit for S down to 0.2 ppm due to XS-Ge-C
- Safe analysis of volatile samples with atmospheric helium mode
- Reduced helium consumption due to vacuum seal
- Safe sample handling with EasyLoad sample detection and SampleCare
- Long measurement times possible with low temperature tube head
- Aut – O – matic: Oxygen analysis with SPECTRA^{plus} feature

Polymers



- Ultra-low detection limit for S down to 0.2 ppm due to XS-Ge-C
- Optimal analysis of Mg in polymers with XS analyzer crystal
- Best detection limits for traces in virgin polymers due to XS-400 analyzer crystal

Quality and Process Control



- HighSense detector technology with MCA for linear ranges up to 2 Mio cps
- 10 primary beam filters
- 4 collimators
- 8 analyzer crystal
- High precision DynaMatch HV generator
- High precision analyzer crystals XS-100, XS-CEM, XS-Ge-C, XS-400
- Smallest particles analysis with 0.3 mm mask

R&D, Academia



- HighSense technology for enhanced analytical precision
- HighSense X-ray tube with 28 μm tube window for best light element excitation
- DynaMatch HV generator up to 170 mA for ultimate light element excitation
- Enhanced light element analysis with dedicated Analyzer crystals: XS-B, XS-C, XS-N-HighSense, XS-55
- Unrivalled analytical flexibility with
 - 10 primary beam filters
 - 4 collimators
 - 8 analyzer crystal
 - 8 sample sizes
- XRF² small spot mapping with best sensitivity due to HighSense optics
- Smallest spot size down to 0.3 mm

	<p>1) PETRO-QUANT ready to analyze solution for 30 trace elements and wear metals in oil, wax, lubricants, water, polymers, slurries</p> <p>2) Norm compliant factory calibrations for</p> <p>a. ASTM: D 2622, D 6443, D 5059</p> <p>b. EN ISO: 14596, 14597, 15597, 20884</p> <p>c. DIN: 13723, 51363, 51391, 51399, 51431, 51790</p>	<ul style="list-style-type: none"> ▪ Lowest cost of operation with reduced helium consumption ▪ Lowest maintenance costs due to SampleCare ▪ Best analytical precision due to longer measurement times possible with low temperature tube head ▪ Long X-ray tube life due to SampleCare 	
	<p>1) POLYMER-QUANT A for the quick analysis of additives in polymers</p> <p>2) RoHS-QUANT ABS for the safe determination of toxic heavy elements in consumer goods</p>	<ul style="list-style-type: none"> ▪ Best analytical precision due to longer measurement times possible with low temperature tube head ▪ High analytical precision with DirectLoading 	
	<p>1) QUANT-EXPRESS for the quick, fast and accurate determination of all product related materials</p> <p>2) ML plus for coating thickness analysis (single and multiple layers)</p>	<ul style="list-style-type: none"> ▪ Cost savings in production due to tighter process and quality control ▪ Lowest cost of operation with SampleCare ▪ High productivity with EZ Ergo technology: TouchControl and EasyLoad ▪ Optimal analytical flexibility for today and future control requirements 	
	<p>1) QUANT-EXPRESS for the quick, fast and accurate determination of all product related materials</p> <p>2) ML plus for coating thickness analysis (single and multiple layers)</p>	<ul style="list-style-type: none"> ▪ Best possible data for light elements ▪ Accurate and precise analysis of bulk and small samples ▪ Unrivalled analytical flexibility ▪ Fast screening of large sample batches ▪ Best spatial resolution for mapping applications ▪ Mapping of traces and light elements 	

S8 TIGER Series 2 – Evolution of Reliability

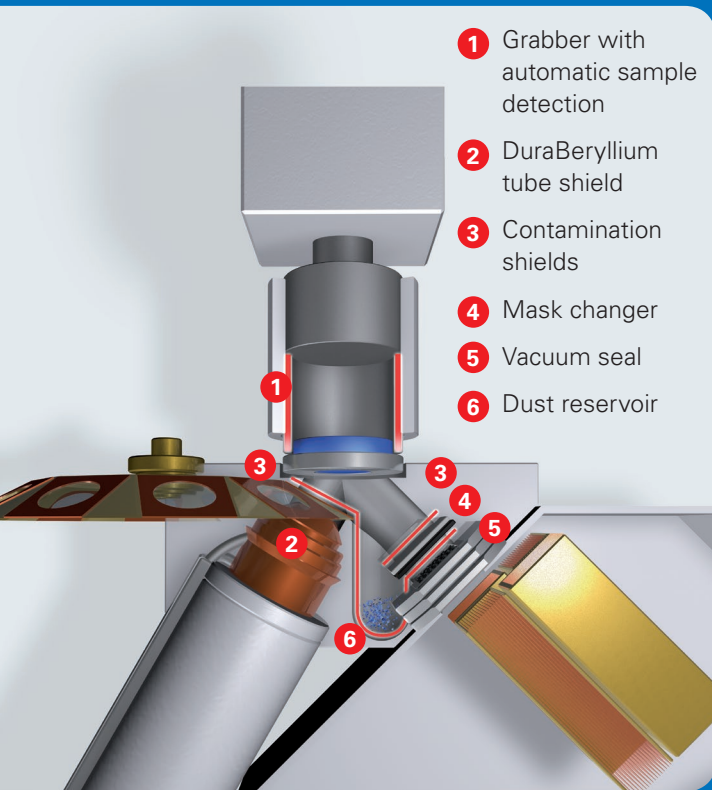

SampleCare™

Low maintenance and high instrument uptime due to unique protection during loading and unloading:

- Two integrated contamination shields for tube and goniometer protection
- Dust reservoir: Dust and liquid collection at safe place and simple cleaning w/o service
- DuraBeryllium™ shield for tube window protection
- Sample Care coating for 50 and 28 μm X-ray tube
- Unique vacuum seal with high transmission window for goniometer protection

A simple recipe leads to success: Continuous analysis, steady improvement, learning, and striving for the best. The S8 TIGER Series has evolved from every past WDXRF generation improving on instrument uptime and robustness.

Thanks to SampleCare you can rely on the S8 TIGER to 100%. SampleCare constantly protects all important system components from contamination, which might lead to incorrect results or in the worst case to system shutdown. Our S8 TIGER with SampleCare prevents this safely in 4 ways: The DuraBeryllium tube shield protects the head of the X-ray tube; the mask changer and the vacuum seal protect the goniometer chamber. If, by chance anything should have gone wrong during preparation and the sample breaks or leaks, this is not a problem. System components are well protected, easy to access, and can be cleaned with little effort.

The S8 Tool software continuously monitors all system parameters and offers a clear view to users what is happening. In case of trouble, a simple click on the FIRST AID button brings the instrument back to normal conditions. Visual warnings indicate preventative maintenance tasks to be scheduled.

When it comes to instrument uptime, low running cost, and easy maintenance, there is no better deal than the S8 TIGER.

- Safe analysis of delicate samples with automatic sample recognition
- Unique instrument protection due to contamination shields
- Lowest maintenance and best system uptime
- Most flexible sample handling –
- Convenient sample loading with trays

Latest WDXRF Technology made in Germany

Bruker develops, designs, and manufactures the S8 TIGER Series 2 in Karlsruhe, Germany. To deliver best quality and optimum performance, latest XRF technology and core components of the S8 TIGER Series 2 are specifically developed and made for this instrument at Bruker's plant in Karlsruhe.

It starts with vital components, such as the goniometer in our machine shop, the HighSense HV generator or the XS Series analyzer crystals. Based on the specifically for the S8 TIGER developed X-ray tubes and the HighSense detectors, the spectrometer are fine-tuned for optimum analytical performance in the Karlsruhe test center prior to shipment.

With our worldwide presence, our local service hubs, and the engaged service team, Bruker supports its customers worldwide. We offer different levels of service and maintenance contracts and our hotline centers support our customers with modern WebEx service tools. The Bruker application team provides excellent factory training and onsite support globally to offer best customer service from A to Z.

Any question left – simply call!



Bruker facility in Karlsruhe



XRF production in Karlsruhe, Germany



Bruker's worldwide service organization for total customer satisfaction

Technical Data

Systems	S8 TIGER 1K	S8 TIGER 3 kW	S8 TIGER 4 kW
	1 kW 50 kV max. 50 mA max.	3 kW 60 kV max. 150 mA max.	4 kW 60 kV max. 170 mA max.
X-ray tubes	Rh, 75 µm Be Window	Rh, 75 µm Be Window Rh, 50 µm Be Window, SampleCare protective coating Rh, 28 µm Be Window, SampleCare protective coating Cr, max.3.3 kW	Rh, 75 µm Be Window
Collimator	Automatic collimator changer (up to 4)		
Analyzer crystals	Automatic crystal changer (up to 8) Included: XS-55, PET, LiF (200) Optional: XS-B, XS-C, XS-N, XS-PET-C, XS-CEM, XS-Ge-C, LiF (220), LiF (420), ADP, Ge, TIAP, InSb, XS-400, XS-100		
HighSense Detectors	Proportional flow counter and Scintillation Counter with MCA technology		
DynaMatch™	Linear intensity range more than 13 million cps		
XRF^{2 1)}	High Resolution and high Intensity Element Mapping with 0.3 mm and 1.25 mm spot (FWHM)		
Automated Mask Changer	Automatic masks (up to 3): closed (SampleCare;) 34 mm, 28 mm, 23 mm, 18 mm, 8 mm (BeamGuide), 5 mm (BeamGuide)		
TouchControl™¹⁾	Integrated touchscreen for easy and intuitive operation		
SampleCare™¹⁾	X-ray tube and goniometer protected by contamination shields Sample and spectrometer chamber separated by programmable vacuum seal		
EasyLoad™¹⁾	Automatic sample recognition Portable sample trays		
Power requirements	208 – 240 V (1P/3P) 50/60 Hz	208 V, 60 Hz (1P/3P) 230 V, 50/60 Hz (3P)	
Compressed air	Not required		
Detector gas	P5 gas (5% methane, 95% argon) for flow counter P10 gas (10% methane, 90% argon) for flow counter		
External cooling water	No cooling water	Cooling water Water consumption automatically regulated and minimized, short term interruptions are compensated	
Dimensions (height x width x depth)	135 cm x 84 cm x 90 cm; 53.1" x 33.1" x 35.4"	135 cm x 84 cm x 104 cm; 53.1" x 33.1" x 41"	
	Touchscreen: Allows additional width of 49 cm (19.3")		
	446 kg	476 kg	
Quality & safety	DIN EN ISO 9001:2008 CE certified Fully radiation protected system; radiation < 1 µSv/h		

1) optional packages

 **Bruker AXS GmbH**
info.baxs@bruker.com

Worldwide offices
bruker.com/baxs-offices

Online information
bruker.com/s8tiger

